

SAGINAW CONTROL & ENGINEERING

SCE-84XDR2D18

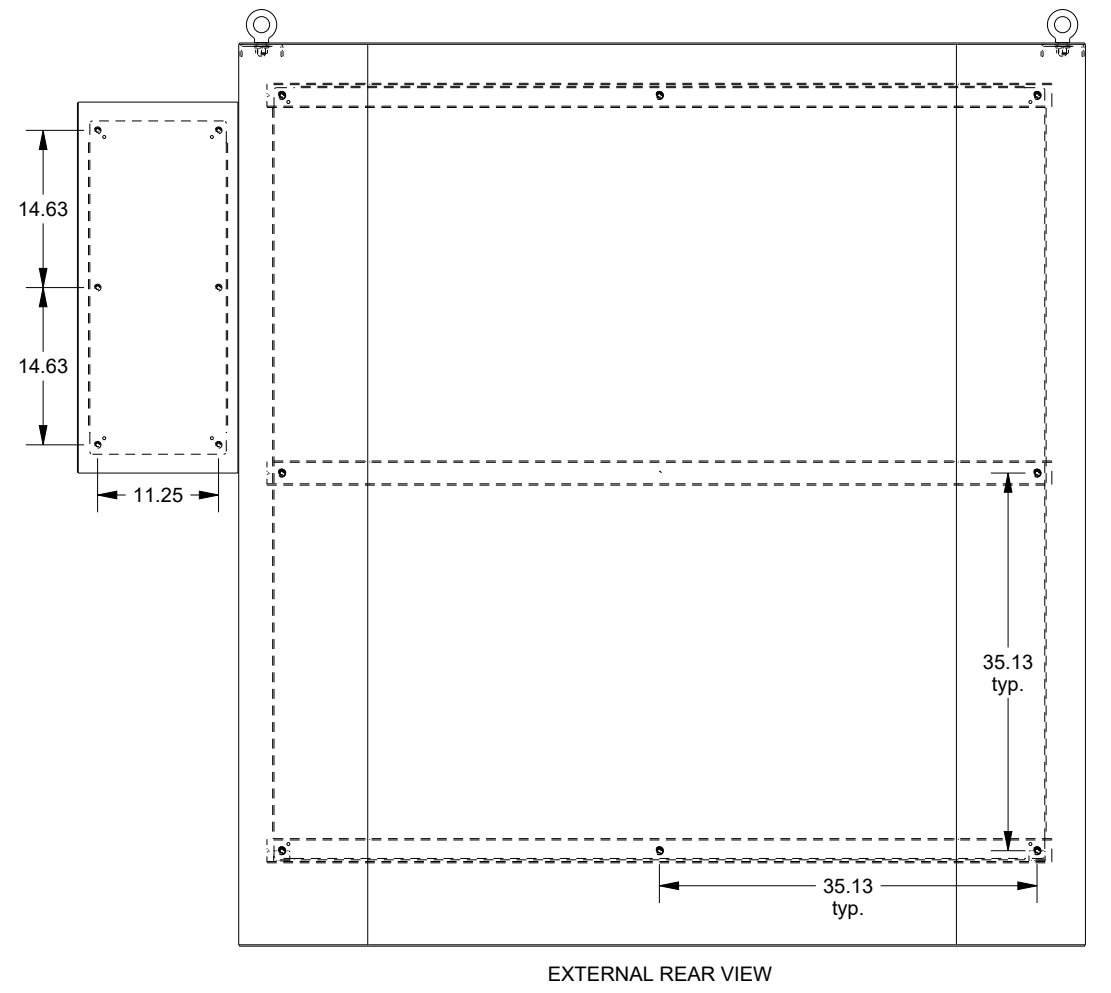

WASH SYSTEM 2" SQUARE DRAIN HOLES IN THE BOTTOM WITH UL APPROVED HOLE SEALS PROVIDED

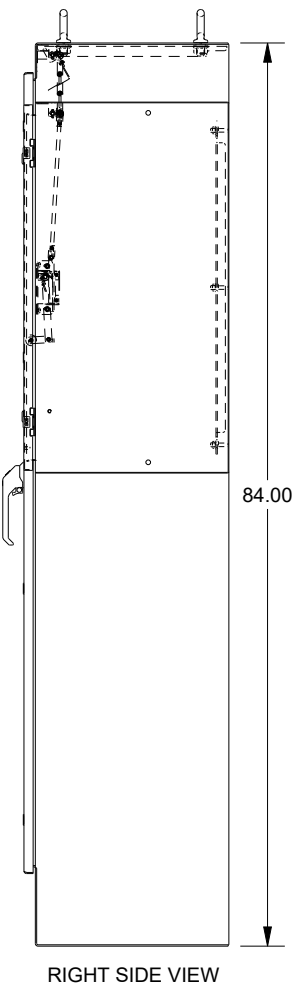
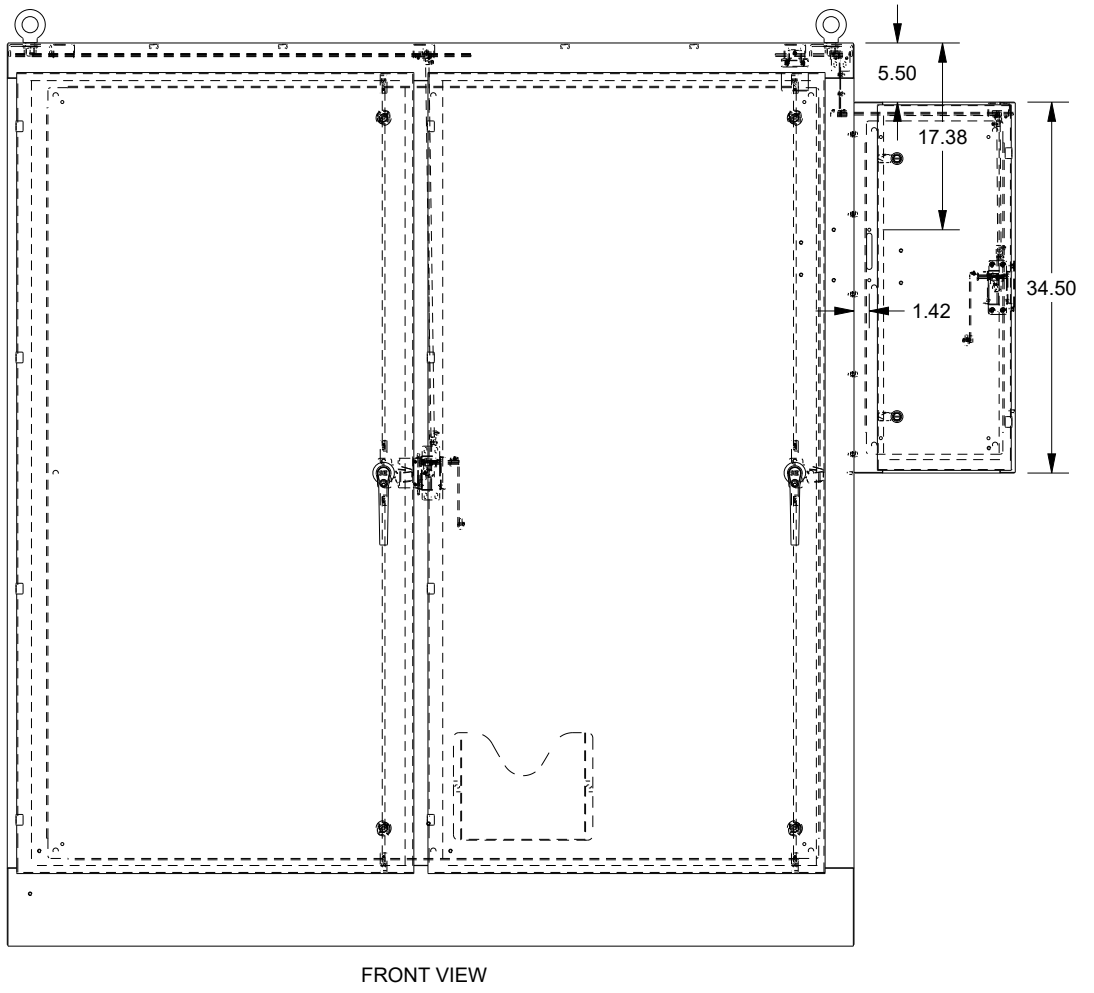
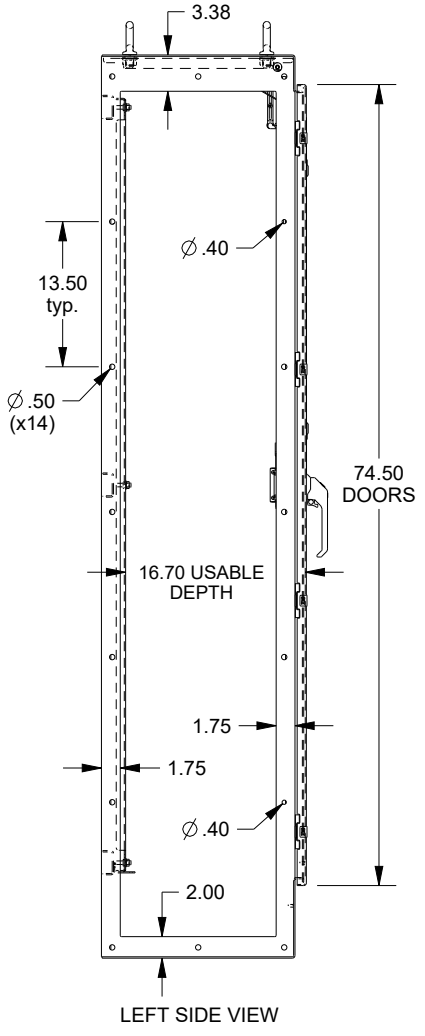
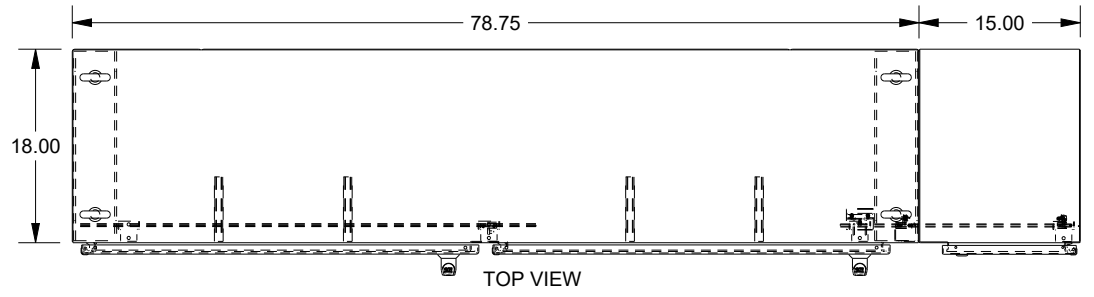